

720.1 – 723.1



720.1 up to 723.1 in survey

- Easy to operate
- Low maintenance
- Long service life
- Flexible installation
- Easy to install
- Design acc. to 97/23/EG
- High-quality materials

Technical data

Type	Nominal width DN	Max. admissible operating pressure		Content	
		bar	psi	Litres	Gallons
720.1	5	10	145	0,025	0,0066
721.2	10	10	145	0,14	0,037
722.1	15	10	145	0,32	0,085
723.1	20	10	145	0,86	0,227

Dimensional drawing

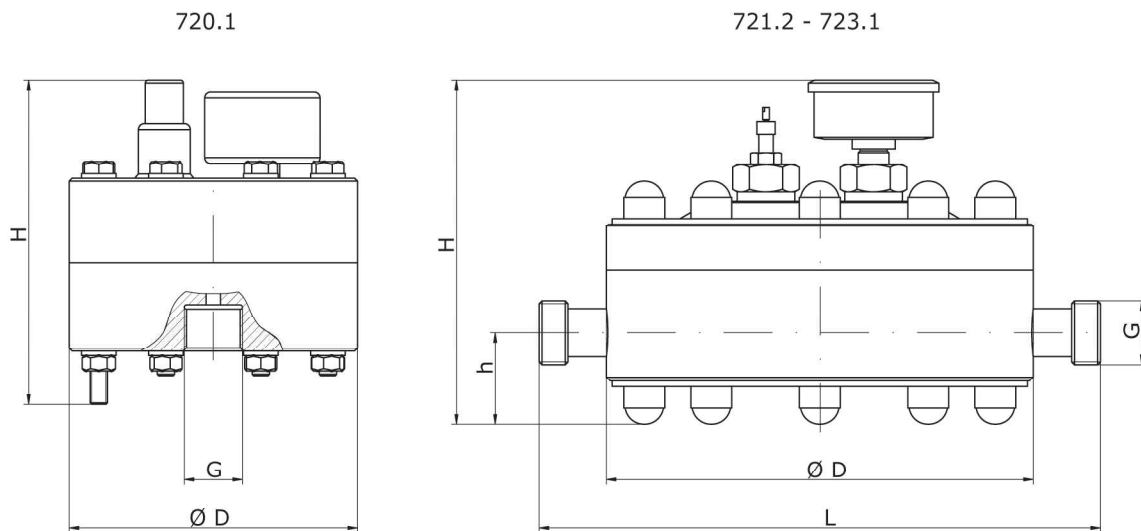

Dimensional chart

Indications in mm / inch

Type	G	D		L		h		H		Weight (kg)		
		mm	in	mm	in	mm	in	mm	in	PVC-U	PP	PVDF
720.1	G 1/2	100	3,94	–	–	–	–	115	4,53	0,9	0,9	1
721.2	G 3/4	180	7,09	250	9,84	45	1,77	165	6,50	4,5	3,5	5
722.1	G 1	222	8,74	292	11,50	48	1,89	180	7,09	6,5	5,0	7
723.1	G 1 1/4	280	11,02	330	12,99	46	1,81	211	8,31	11,5	8,0	13

■ Indication of weight for basic design acc. to order information

Order information

Diaphragm-pulsation damper

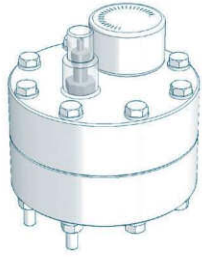

Basic design:

- Manometer d 40, 0-16 bar, plastic housing, measuring system copper alloy, filling valve,
- PVDF-design: upper part (not medium-contacting) made of PVC-U
- Diaphragm: PTFE

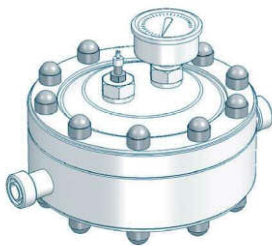

Type	Thread connection	Material		
		PVC-U	PP	PVDF
		Article-No.	Article-No.	Article-No.
720.1	G 1/2	37601848	37601856	37601857



Basic design:

- Manometer d 63, 0-16 bar, sheet steel housing, measuring system copper-alloy, filling valve,
- PVDF-design: upper part (not medium-contacting) made of PVC-U
- Diaphragm: PTFE-faced, seals: FPM

Type	Thread connection	Material		
		PVC-U	PP	PVDF
		Article-No.	Article-No.	Article-No.
721.2	G 3/4	37602013	37602017	30100012
722.1	G 1	30100008	30100009	30100010
723.1	G 1 1/4	30100011	30100012	30100013

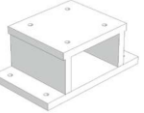
Options/Accessories		720.1	721.2 722.1	723.1
Filling pump FLP 2  <p>for filling device, max. 7 bar (101 psi), with manometer, 2 m (6.5 ft) hose, coupling piece for air hose</p>		90009396	90009396	90009396
Connection adapter  <p>Thread connection: G 3/4 Connection pulsation damper: G 1/2 external</p>	Material Adapter / Sealing:			
	PVC-U/FPM	90021733	–	–
	PVC-U/EPDM	90025079	–	–
	PP/FPM	90038083	–	–
	PP/EPDM	90038082	–	–
	PVDF/ FEP-covered	Ⓢ	–	–
Console for wall mounting  <p>PP</p>		–	–	90011722

Pulsation damper

Diaphragm-pulsation damper
up to 10 bar

720.1 – 723.1

Options/Accessories					720.1	721.2 722.1	723.1
	2 pieces per pulsation damper	PP	d16	90010649	–	–	
			d25	–	90010651	–	