

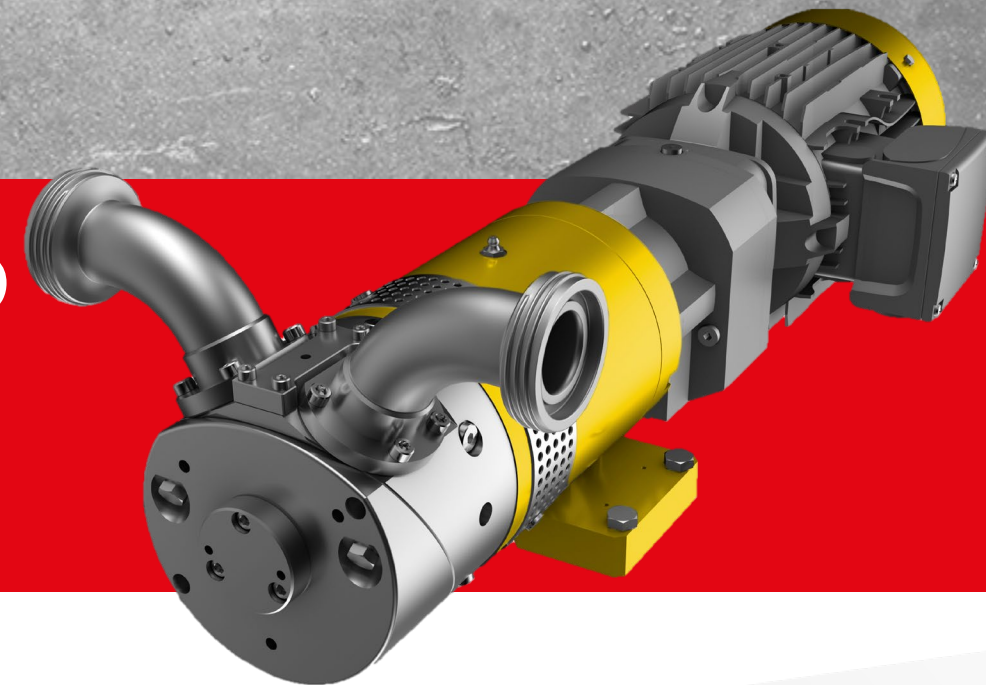

WOBBLE PLATE PUMP TRP



Promotion of sophisticated media

safety is our concern

Product information

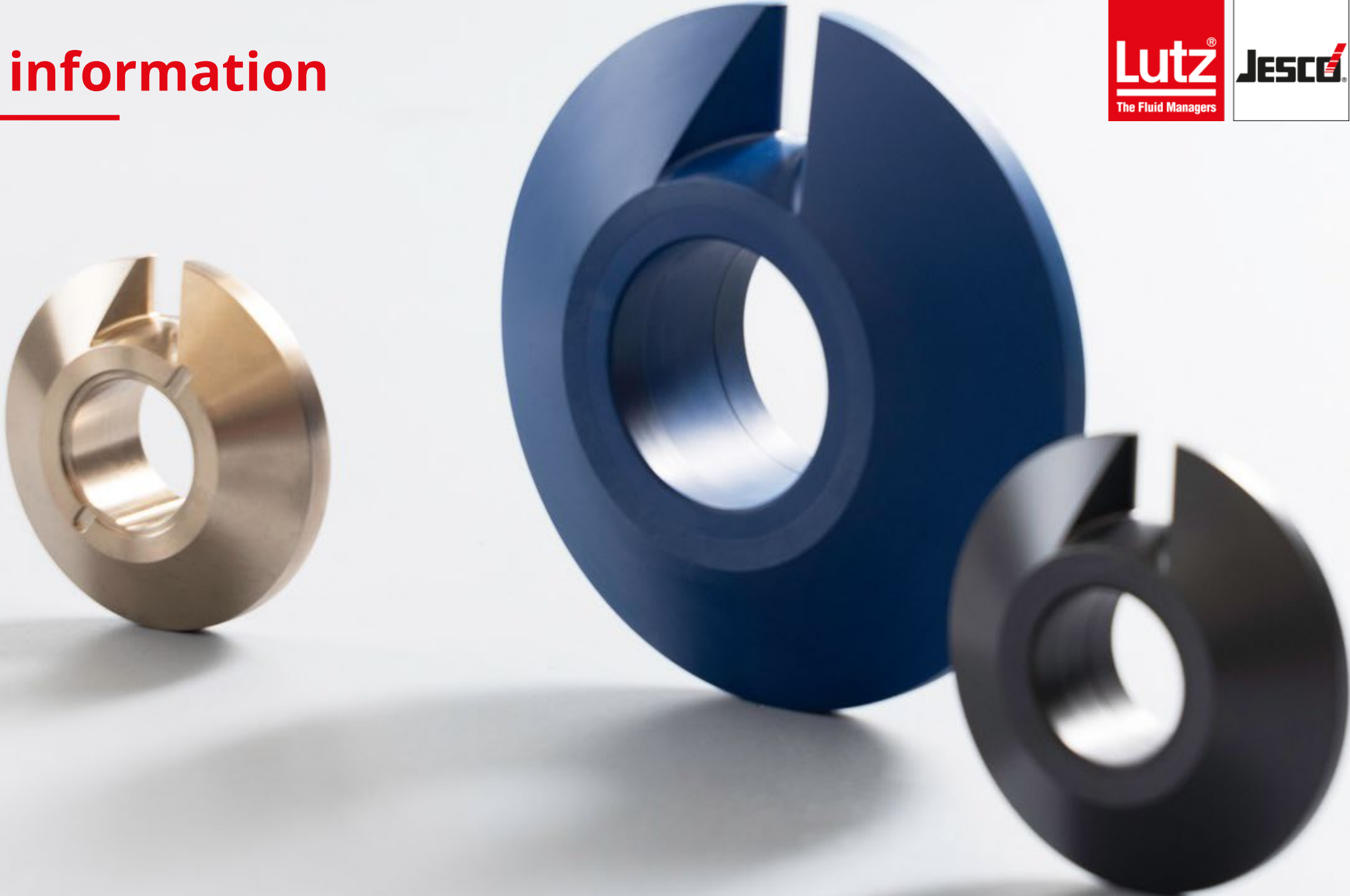

All common connection types can be selected

Lutz[®]
The Fluid Managers

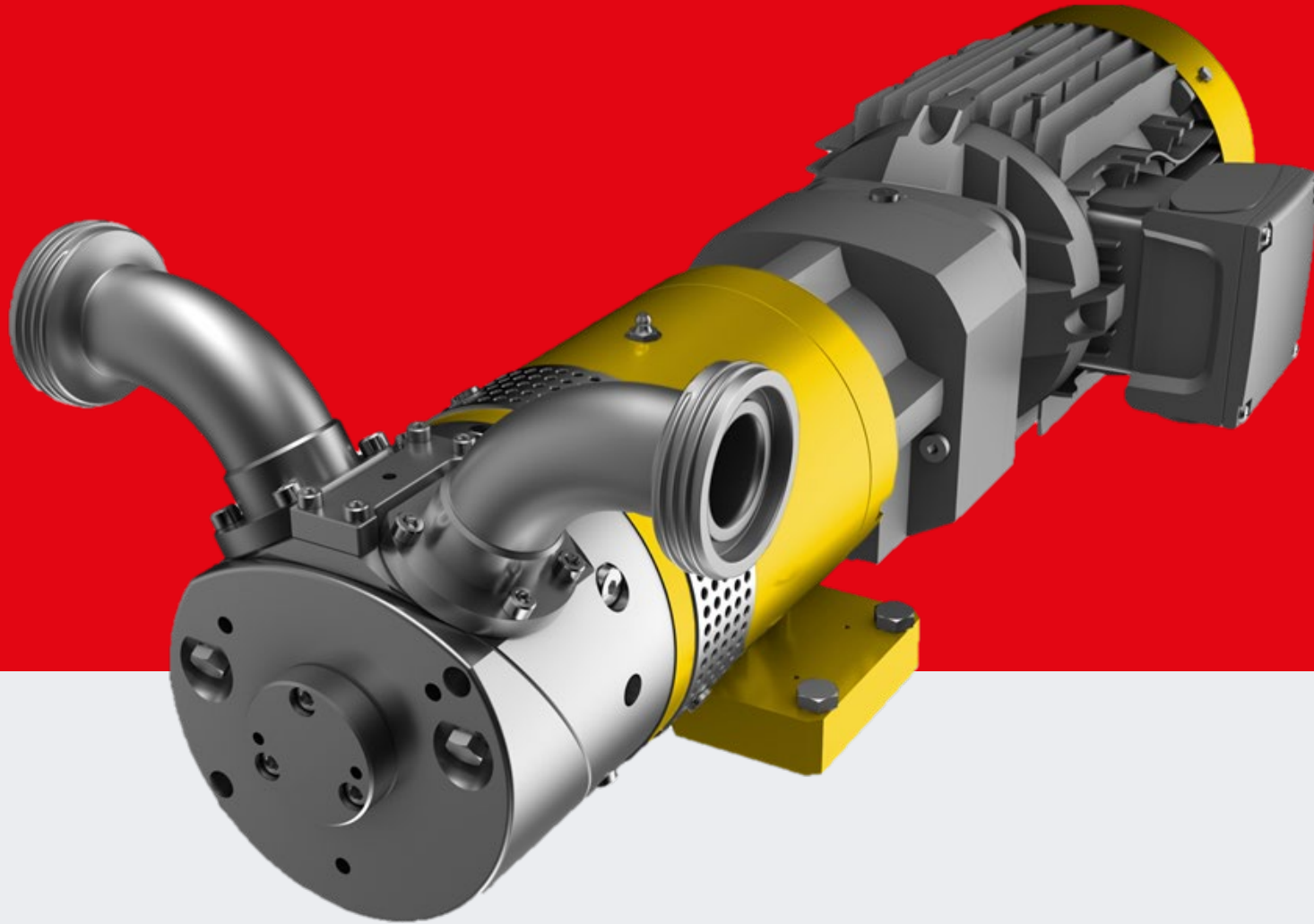

- Flange
- Dairy pipe
- TriClamp
- Camlock

All common connection types can be selected

Lutz[®]
The Fluid Managers

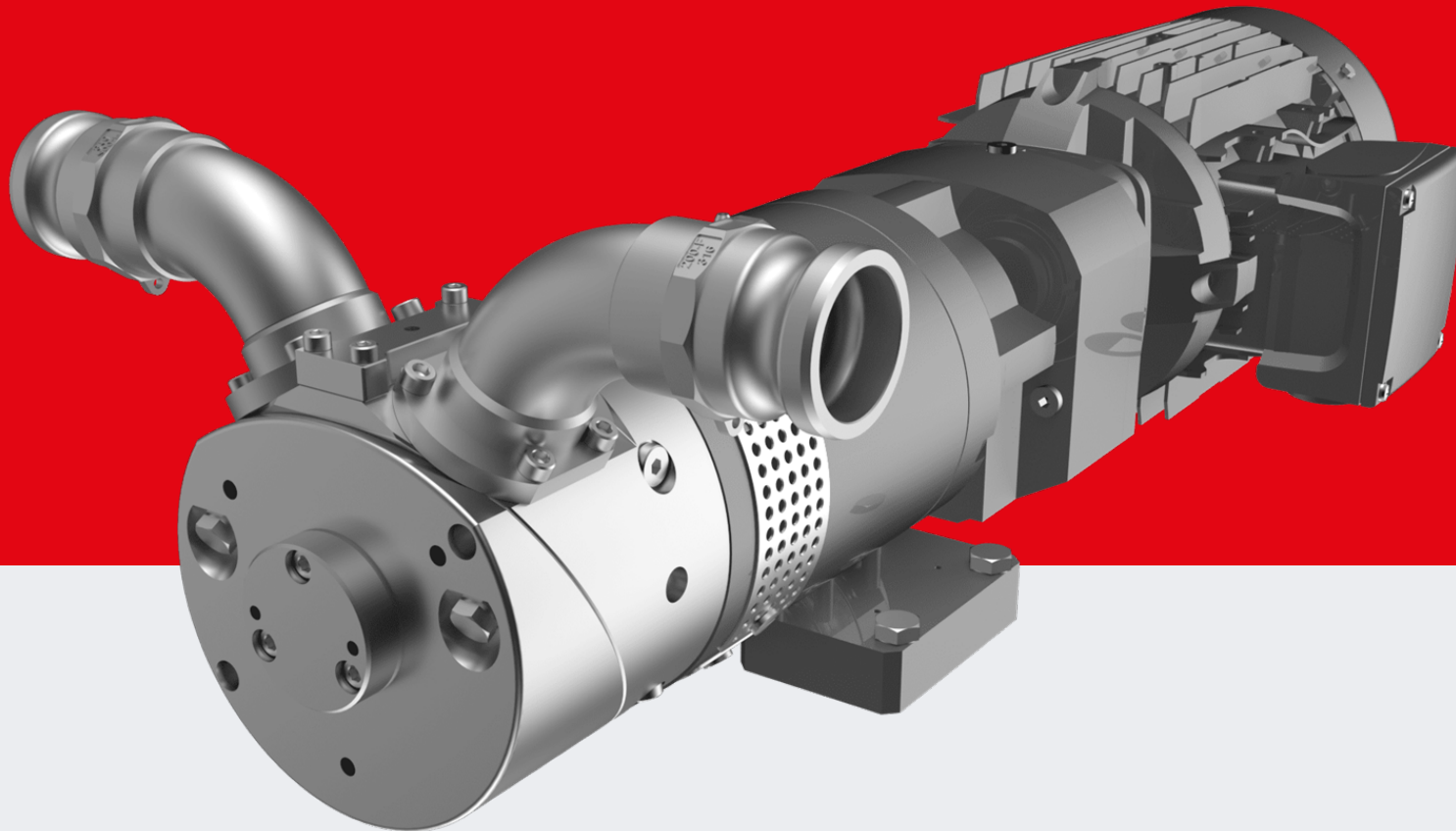

- Flange
- Dairy pipe
- TriClamp
- Camlock

Maximum flexibility for customised solutions



Rotatability of
the pump head
in 90° steps:

- 90°
- 180°
- 270°
- 360°

Always there where you need them



Horizontal
installation



Vertical
installation



Mobile
installation

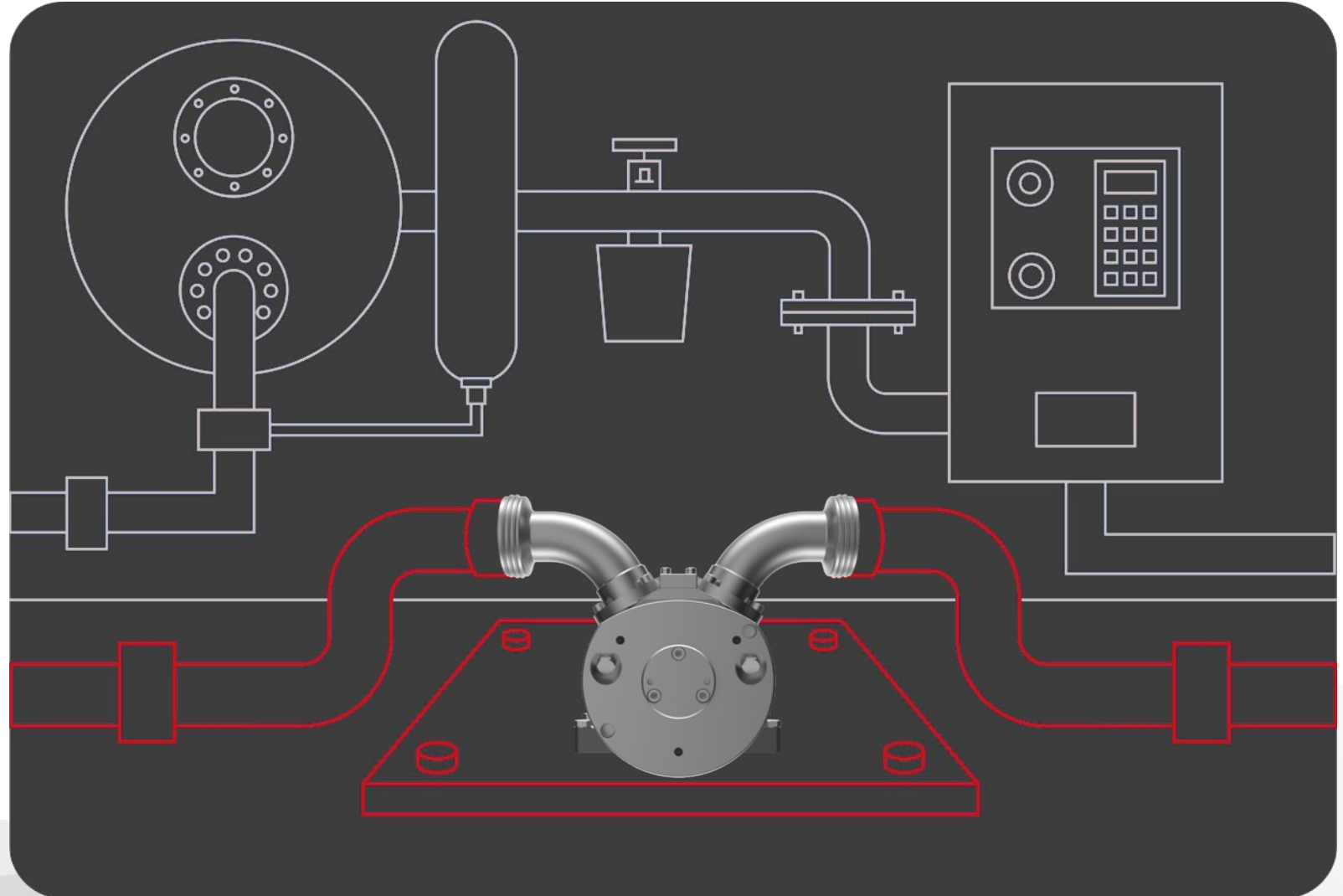

Always there where you need them



Horizontal installation



Vertical installation



Mobile installation

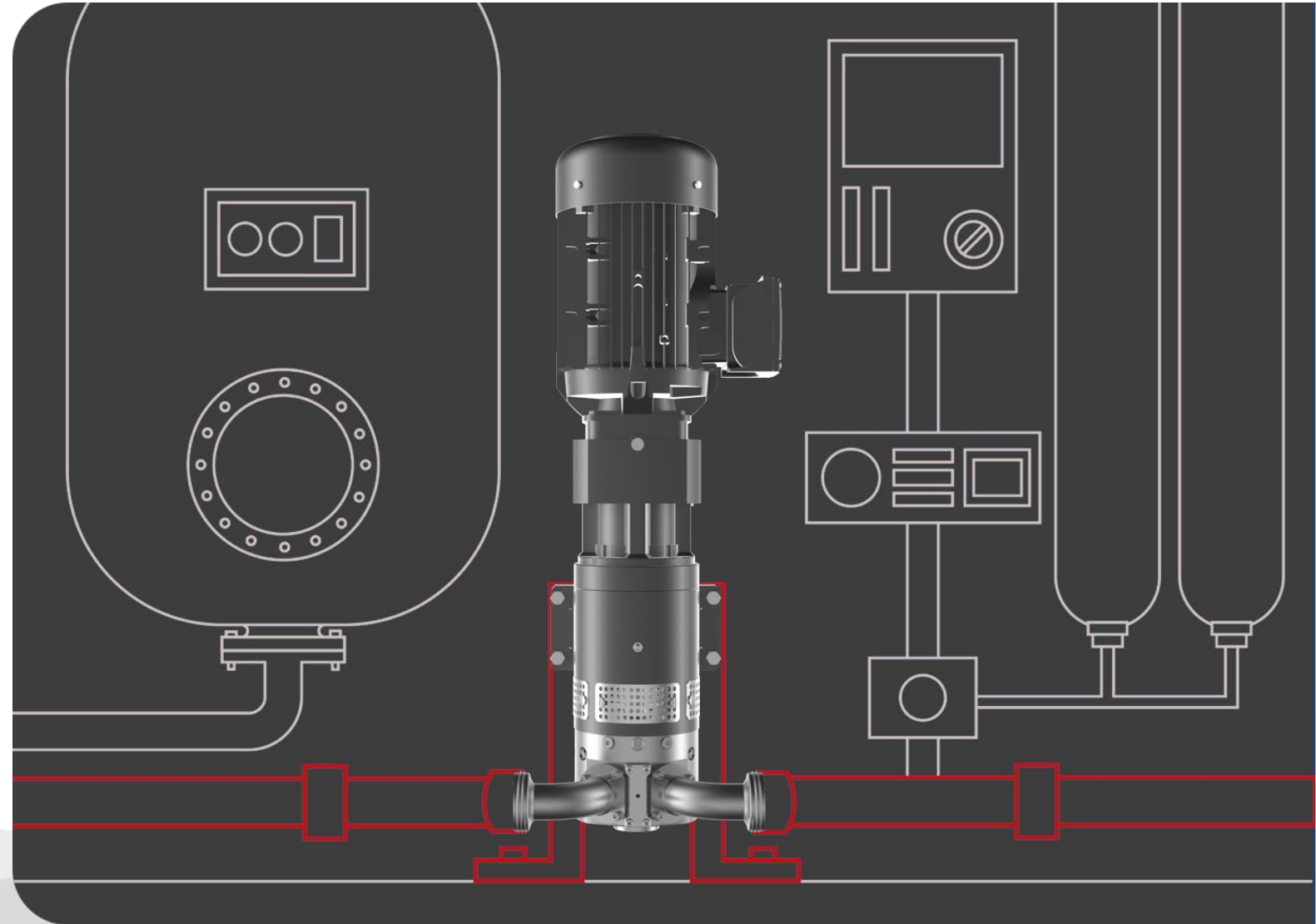

Always there where you need them



Horizontal
installation



Vertical
installation



Mobile
installation

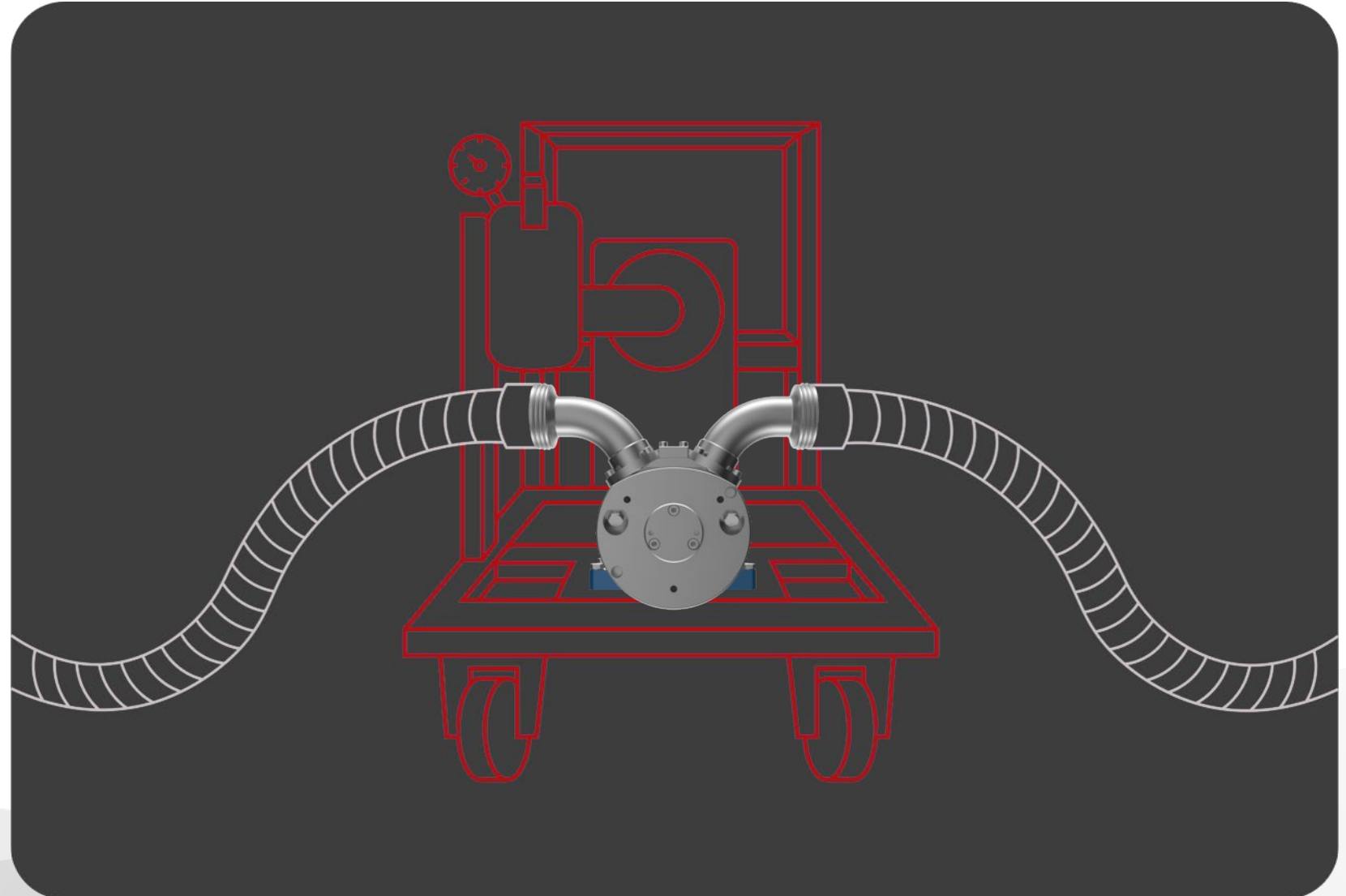

Maximum performance



- Flow rates of up to 30 m³/h
- High system availability
- Long service life
- Low wear
- Robust

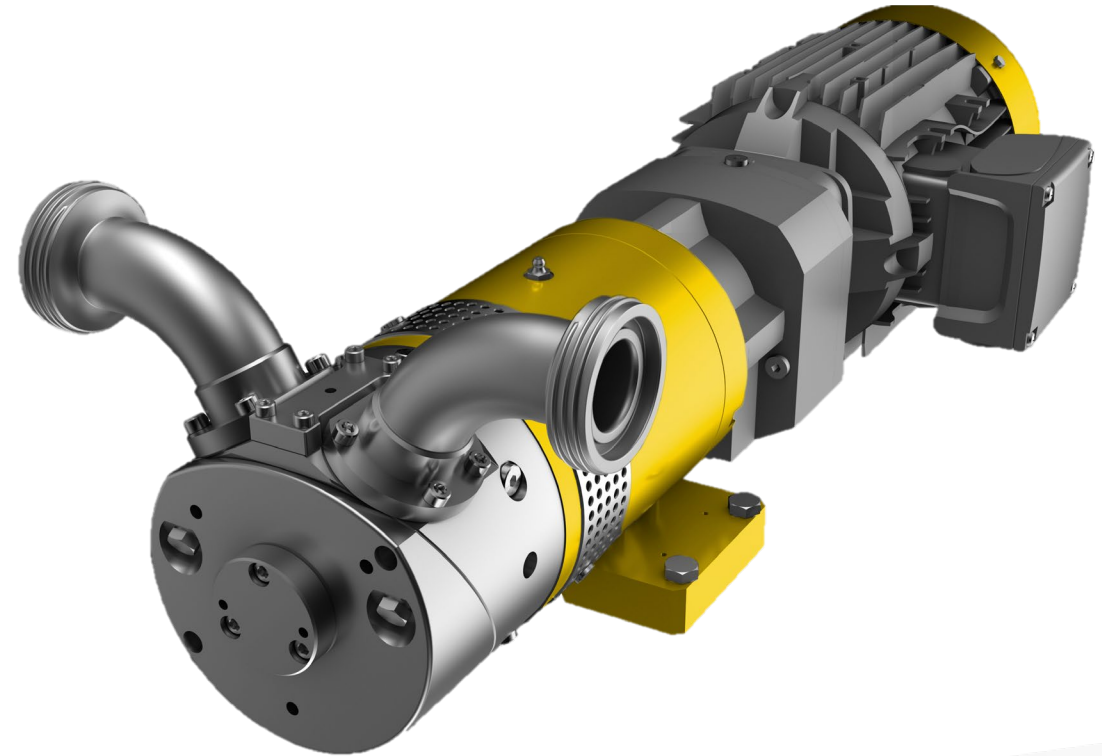

Minimum maintenance



- Maintenance and service
- easy disassembly of
→ quick cleaning and
pump chamber with
- Process-controlled cleaning
CIP - Cleaning-In-Place
SIP - Sterilisation-In-Place



Particularly sustainable



- Significant energy savings compared to other pump types
- Conserves resources thanks to the compact design







Technology



Characteristic curve with medium water 18°C

Characteristic curves TRP015

Model TRP015

Model TRP030

Model TRP080

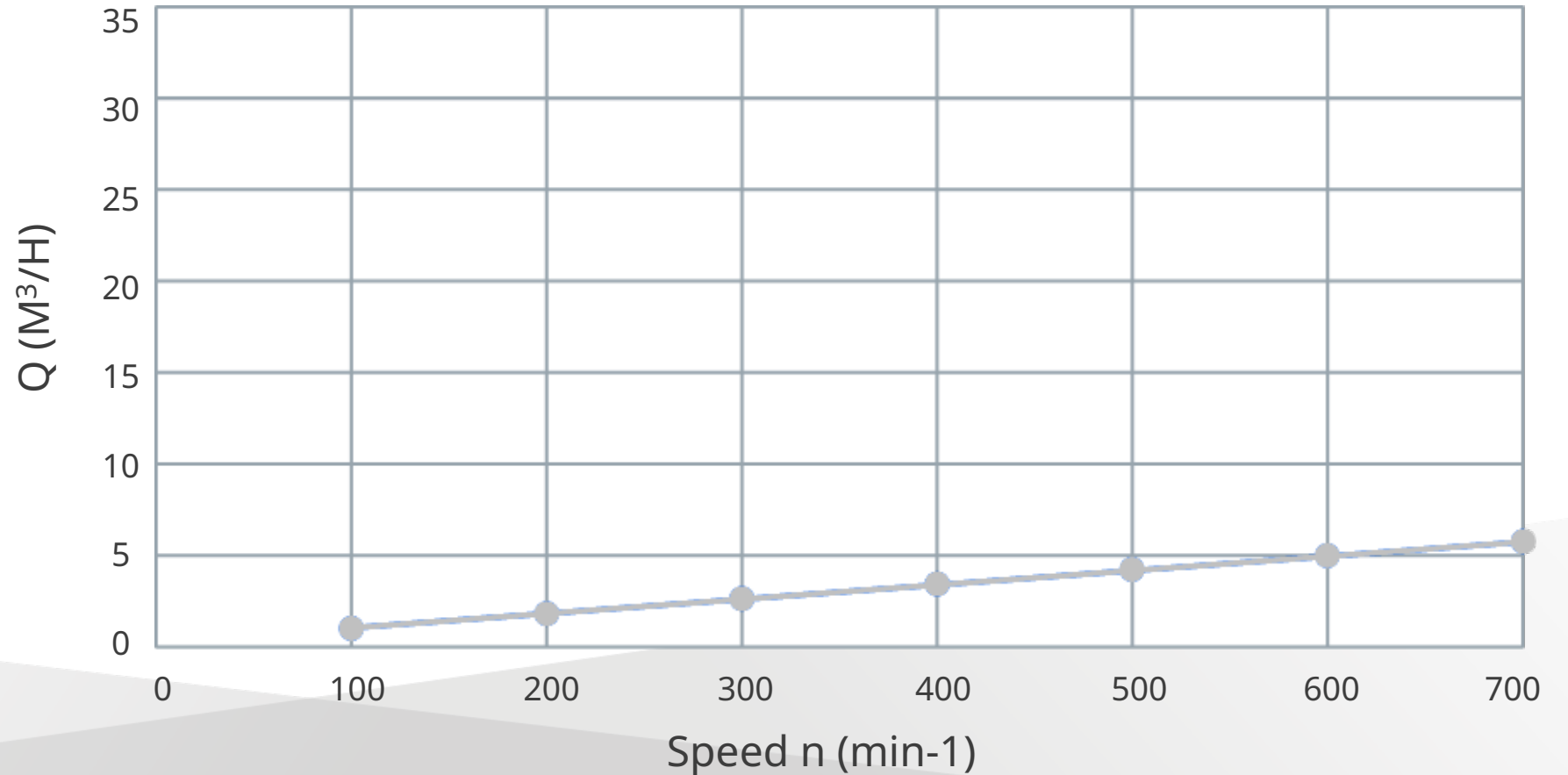

Technology



Characteristic curve with medium water 18°C

Characteristic curves TRP015 + TRP030

Model TRP015

Model TRP030

Model TRP080

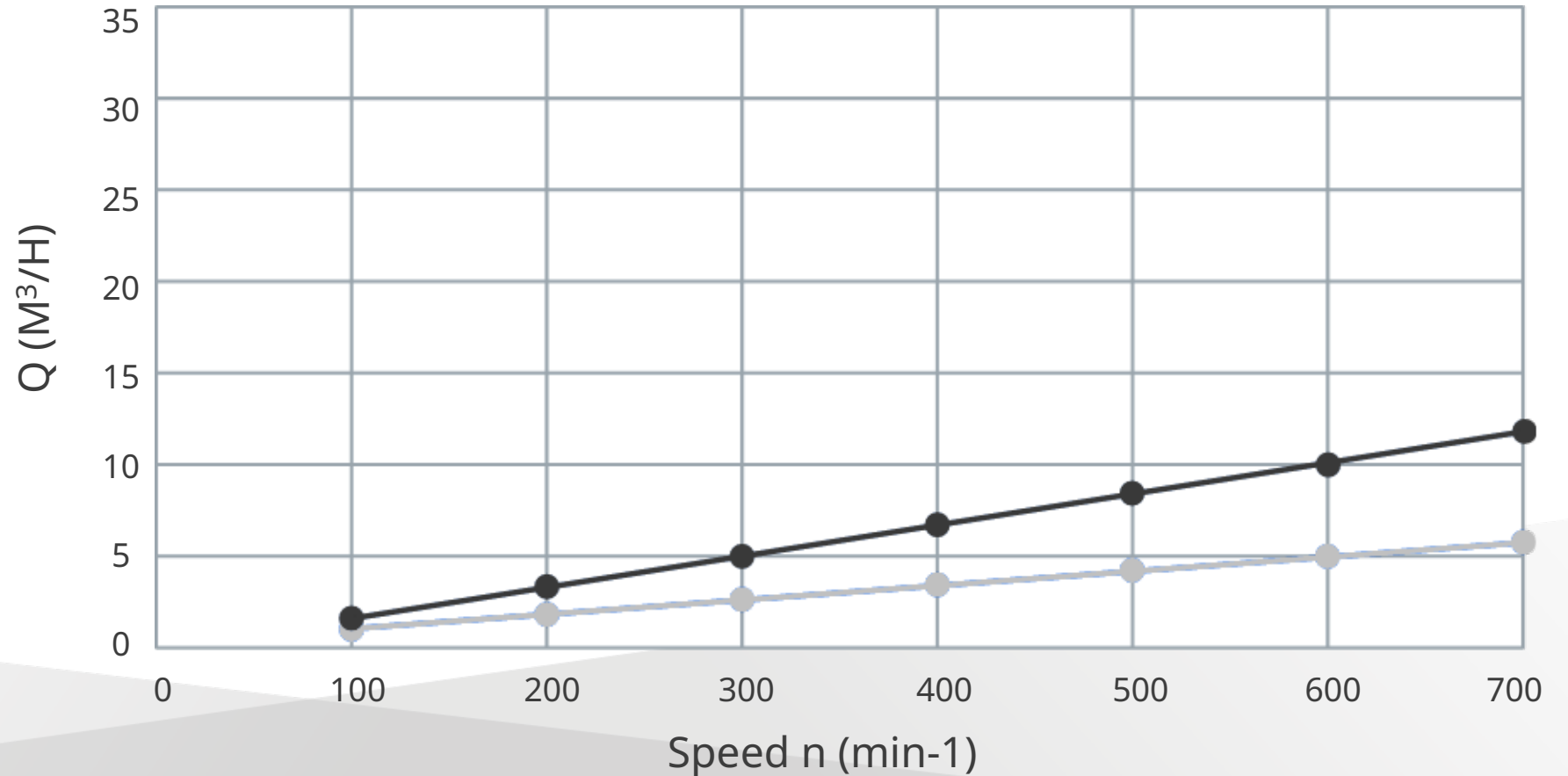

Technology



Characteristic curve with medium water 18°C

Characteristic curves TRP015 + TRP030 + TRP080

Model TRP015

Model TRP030

Model TRP080

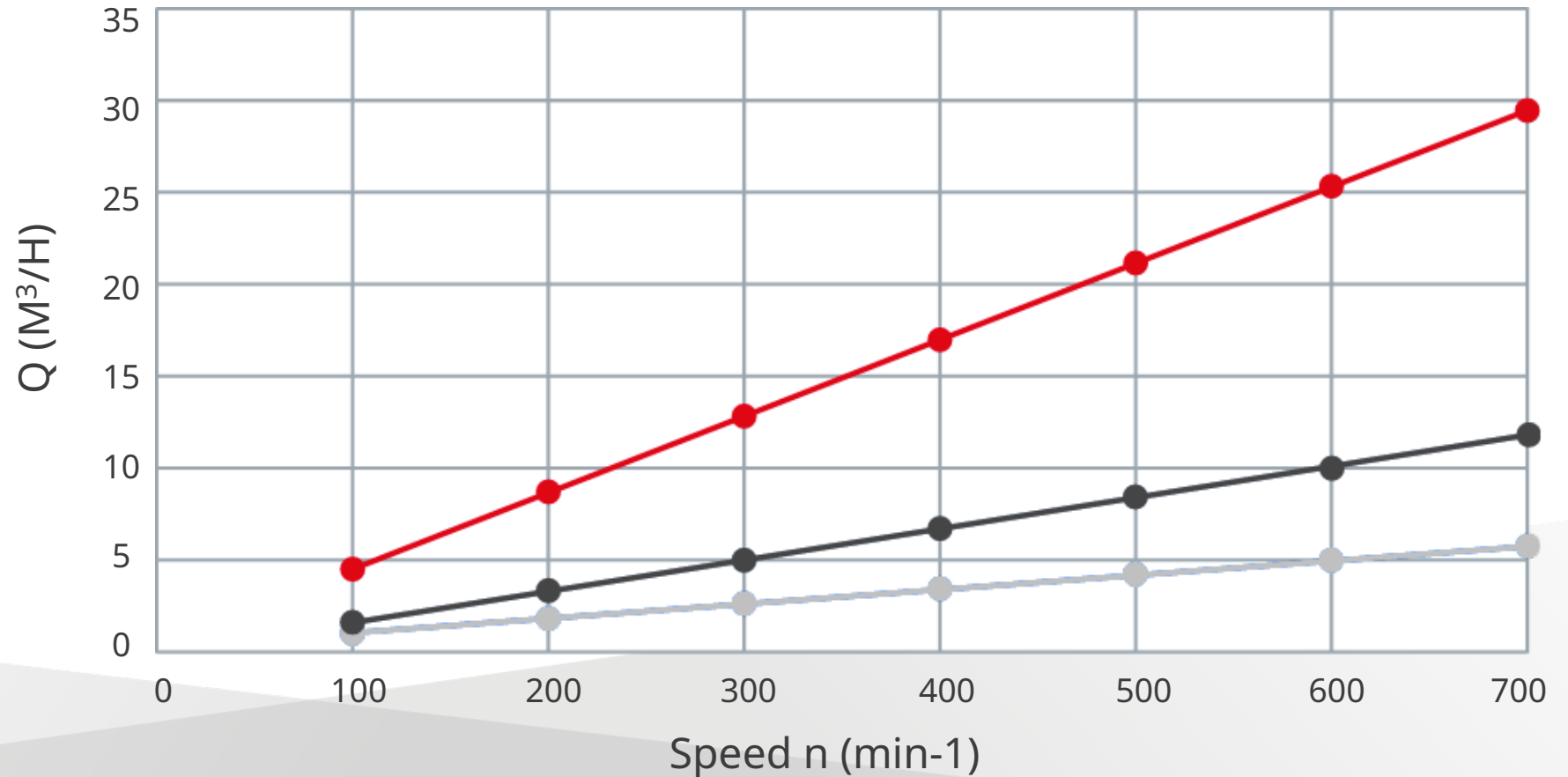

Performance data

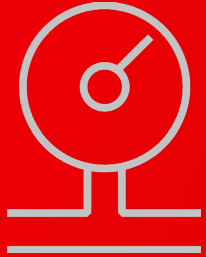

Delivery rates up to 30,000 l/h

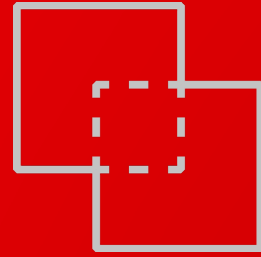

Differential pressures up to 15 bar



Viscosities up to 1,000,000 mPas



Maintenance & servicing in just a few minutes

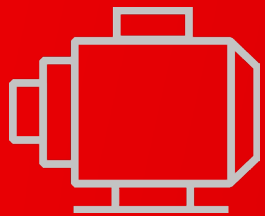

Motor power up to 7.5 kW



ATEX-certification



FDA certification



4 x 90° rotatable pump head

Properties

Lutz[®]
The Fluid Managers



**Gentle conveying
of the pumped
media**

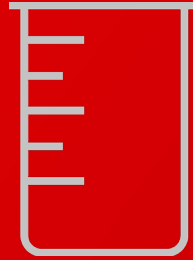

Precise dosing

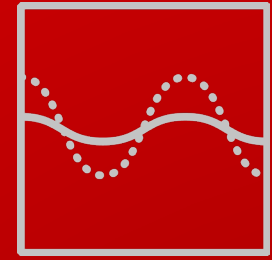

**Low pulsation
Promotion**

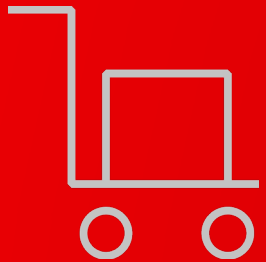

**Mobile body
(optional)**



**Can be tempered
or cooled (optional)**

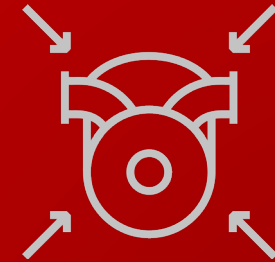

**Kompact
design**

Technology



Dimensions, materials

Model TRP015

Model TRP030

Model TRP080

Delivery pressure

- up to 10 bar

- up to 15 bar

- up to 15 bar

Capacity

- up to 6,000 l/h

- up to 12,000 l/h

- up to 30,000 l/h

Motor power

- Up to 3.0 kW

- Up to 5.5 kW

- 7.5 kW

Technology



Dimensions, materials	Model TRP015	Model TRP030	Model TRP080
Dimensions	<ul style="list-style-type: none">▪ Diameter 150 mm▪ Length 316 mm (plus motor and gear)	<ul style="list-style-type: none">▪ Diameter 170 mm▪ Length 340 mm (plus motor and gear)	<ul style="list-style-type: none">▪ Diameter 210 mm▪ Length 440 mm (plus motor and gear)
Weight	<ul style="list-style-type: none">▪ 45 kg (incl. drive)	<ul style="list-style-type: none">▪ 90 kg (incl. drive)	<ul style="list-style-type: none">▪ 135 kg (incl. drive)
Pump head material	<ul style="list-style-type: none">▪ Stainless steel	<ul style="list-style-type: none">▪ Stainless steel	<ul style="list-style-type: none">▪ Stainless steel
Material wobble plate	<ul style="list-style-type: none">▪ Plastic or metal (depending on medium)	<ul style="list-style-type: none">▪ Plastic or metal (depending on medium)	<ul style="list-style-type: none">▪ Plastic or metal (depending on medium)

Standard version



Version	Model TRP015	Model TRP030	Model TRP080
Drive power	<ul style="list-style-type: none">▪ 1.5 kW	<ul style="list-style-type: none">▪ 5.5 kW	<ul style="list-style-type: none">▪ 7.5 kW
Mechanical seal	<ul style="list-style-type: none">▪ Single-acting	<ul style="list-style-type: none">▪ Single-acting	<ul style="list-style-type: none">▪ Single-acting
Seals	<ul style="list-style-type: none">▪ EPDM	<ul style="list-style-type: none">▪ EPDM	<ul style="list-style-type: none">▪ EPDM
Built-in set	<ul style="list-style-type: none">▪ "soft"	<ul style="list-style-type: none">▪ "soft"	<ul style="list-style-type: none">▪ "soft"
Material wobble plate	<ul style="list-style-type: none">▪ Plastic or metal (depending on the medium)	<ul style="list-style-type: none">▪ Plastic or metal (depending on the medium)	<ul style="list-style-type: none">▪ Plastic or metal (depending on the medium)

Variation options



Shaft seal

- Single-acting
- Double-acting mechanical seal with barrier pressure vessel

Wobble plates

- Food industry (FDA) HPV-PPS (Techtron blue)
- Chemical industry Peek-HPV (black)
- Pharmaceutical industry (FDA) Peek-Nature (beige)
- Petrochemical industry Albromet (aluminium bronze)

Sealing variants

- EPDM
- FKM
- FFKM

Built-in set

- "soft"
 - Hardened set
-

Lutz[®]
The Fluid Managers



References & Target groups

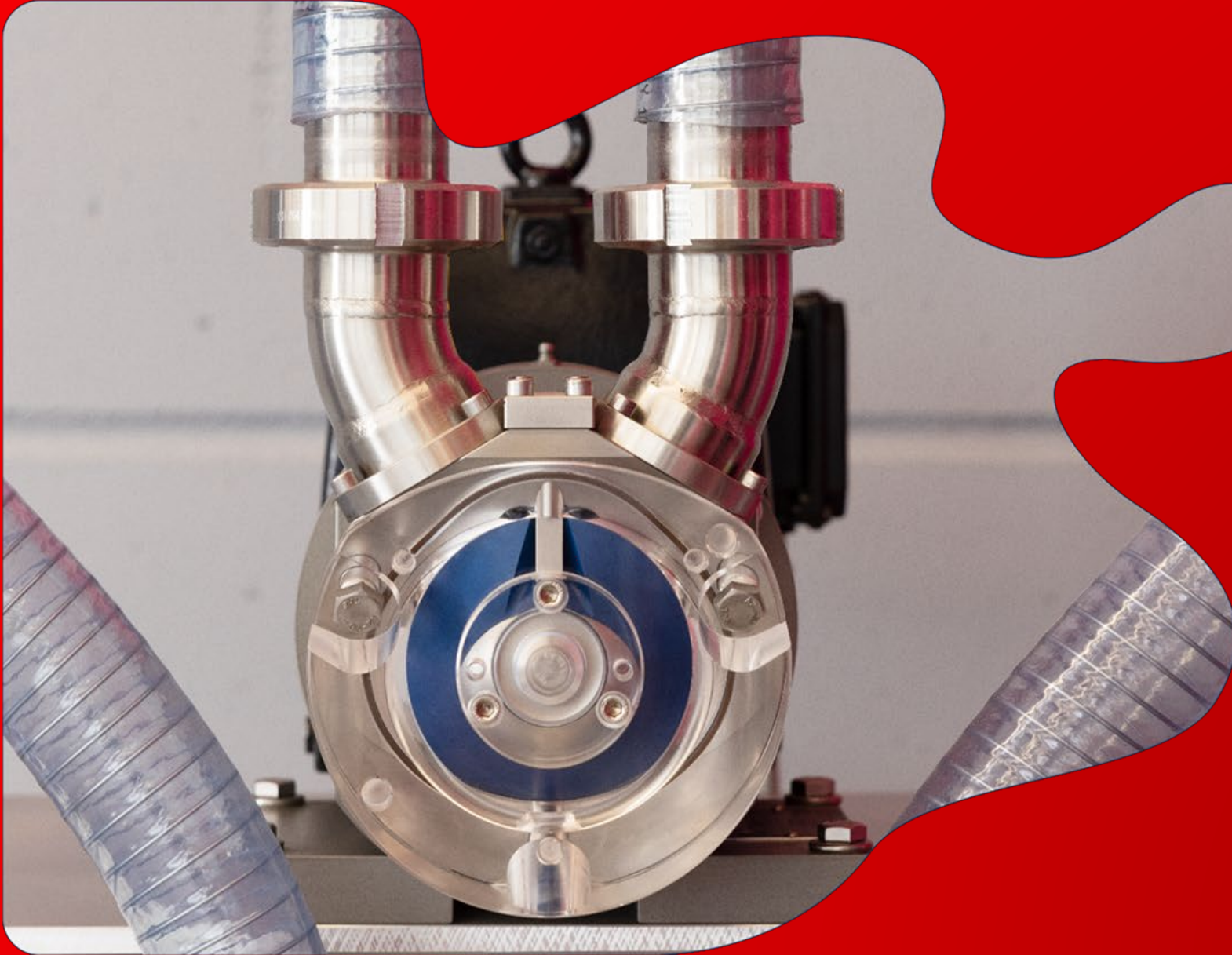

Target groups

- Paint- and Lacquer
- Sealant and adhesive industry
- Pharmaceutical industry
- Cosmetics industry
- Basic chemicals industry
- Oil industry
- Petrochemical industry
- Food industry



Reference: Paint- and Lacquer



"Our cleaning time has been significantly shorter with the new pumps from Lutz Pumpen GmbH. This allows us to switch more quickly between different colour shades of dispersion paints and, most importantly and, above all, we no longer have any impurities from the previously conveyed colour"

Plant technician in a company for paints and varnishes



Reference: Pharmaceutical industry



"Since we have been using the pumps from Lutz Pumpen GmbH have been in use, we notice significantly less shear when pumping our medium. This ensures that the desired consistency is maintained"

Plant technician of a pharmaceutical company

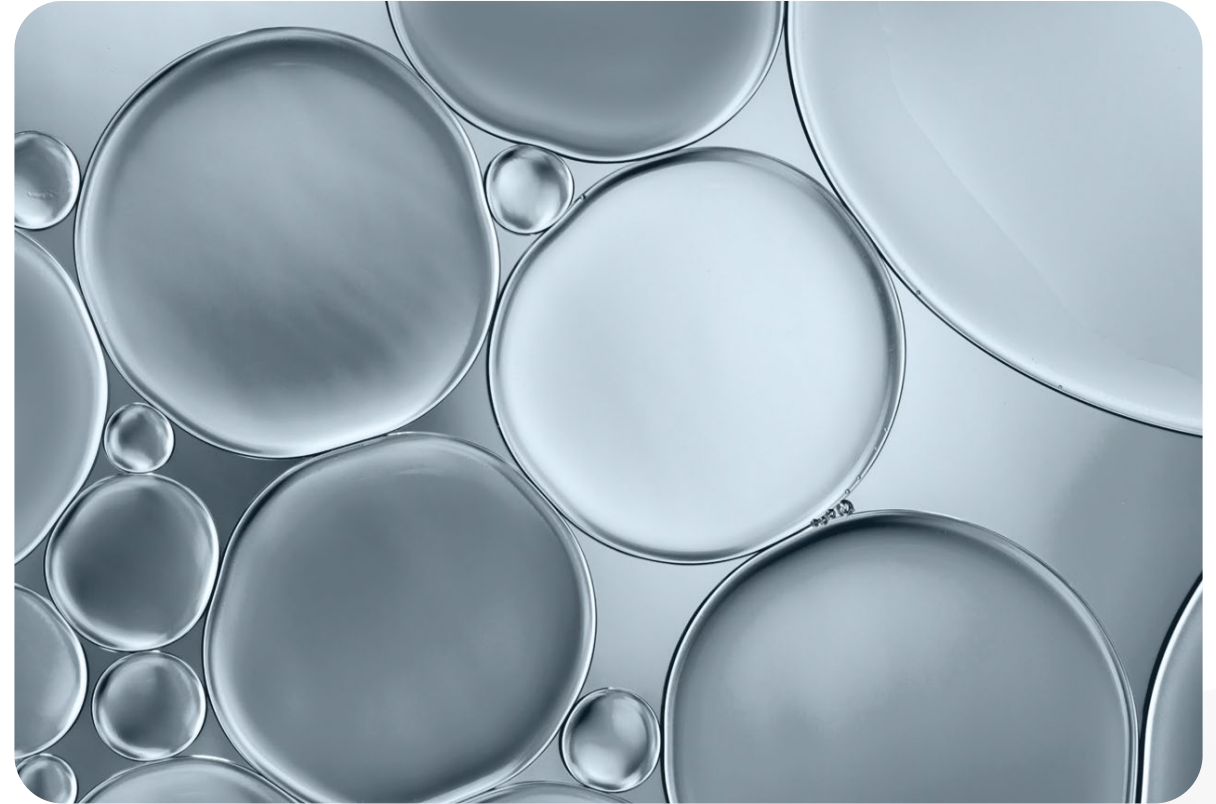

Reference: Cosmetics industry



"After we put the new pumps into operation, we realised that the desired air bubbles in the shampoo are hardly damaged during the pumping process and we can offer the customer a more appealing product overall."

Plant technician of a cosmetics company





safety is our concern